

Aluminum Capacitors Axial Miniature, Long-Life

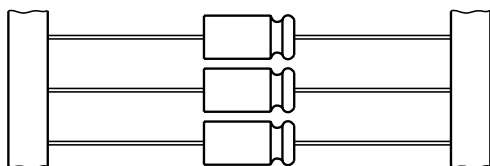
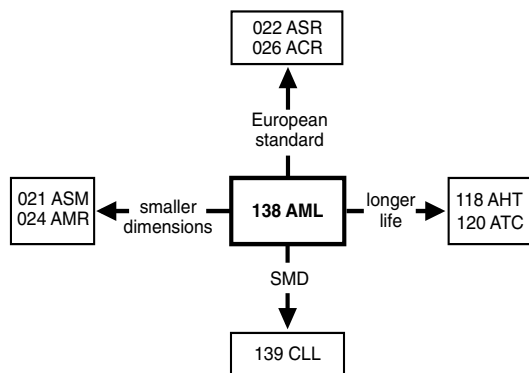

Fig.1 Component outlines



FEATURES

- Polarized aluminum electrolytic capacitors, non-solid electrolyte
- Axial leads, cylindrical aluminum case, insulated with a blue sleeve (case \varnothing 6.3 x 12.7 and 7.7 x 12.7 mm are moulded with flame retardant plastic material)
- Mounting ring version not available in insulated form
- Taped versions up to case \varnothing 15 x 30 mm available for automatic insertion
- Charge and discharge proof
- Long useful life: 2000 to 10 000 hours at 105 °C, high reliability
- High ripple current capability
- Miniaturized, high CV-product per unit volume
- Lead (Pb)-free versions are RoHS compliant



APPLICATIONS

- Industrial, automotive, EDP and telecommunication
- Smoothing, filtering, buffering in SMPS; coupling, decoupling, timing
- Portable and mobile equipment (small size, low mass)
- Stand-by applications
- Low mounting height boards, vibration and shock resistant

MARKING

The capacitors are marked (where possible) with the following information:

- Rated capacitance (in μ F)
- Tolerance on rated capacitance, code letter in accordance with IEC 60062 (M for \pm 20 %)
- Rated voltage (in V)
- Upper category temperature (105 °C)
- Date code, in accordance with IEC 60062
- Code for factory of origin
- Name of manufacturer
- Band to indicate the negative terminal
- '+' sign to identify the positive terminal (not for case sizes L < 18 mm)
- Series number (138)

QUICK REFERENCE DATA	
DESCRIPTION	VALUE
Nominal case sizes (\varnothing D x L in mm)	6.3 x 12.7 to 10 x 25 10 x 30 to 21 x 38
Rated capacitance range, C_R	1.0 to 15 000 μ F
Tolerance on C_R	\pm 20 %
Rated voltage range, U_R	6.3 to 100 V
Category temperature range	- 40 to + 105 °C
Endurance test at 105 °C	1000 hours 5000 hours
Useful life at 105 °C	2000 hours 10 000 hours
Useful life at 40 °C, I_R applied	1.3 x I_R applied: 200 000 hours 1.8 x I_R applied: 500 000 hours
Shelf life at 0 V, 105 °C	500 hours 500 hours
Based on sectional specification	IEC 60384-4/EN130 300
Climatic category IEC 60068	40/105/56

* Pb containing terminations are not RoHS compliant, exemptions may apply

SELECTION CHART FOR CR, UR AND RELEVANT NOMINAL CASE SIZES (Ø D x L in mm)								
C _R (µF)	U _R (V)							
	6.3	10	16	25	40	50	63	100
1.0	-	-	-	-	-	-	-	6.3 x 12.7
2.2	-	-	-	-	-	-	-	6.3 x 12.7
4.7	-	-	-	-	-	-	6.3 x 12.7	7.7 x 12.7
10	-	-	-	6.3 x 12.7	-	6.3 x 12.7	7.7 x 12.7	6.5 x 18
22	-	-	6.3 x 12.7	6.3 x 12.7	-	7.7 x 12.7	6.5 x 18	8 x 18
33	-	-	-	6.3 x 12.7	7.7 x 12.7	-	-	-
47	-	-	6.3 x 12.7	7.7 x 12.7	6.5 x 18	-	8 x 18	10 x 25
68	-	-	-	-	-	-	-	10 x 30
100	6.3 x 12.7	-	7.7 x 12.7	6.5 x 18	8 x 18	10 x 18	10 x 25	12.5 x 30
150	-	7.7 x 12.7	-	-	-	-	10 x 30	15 x 30
220	7.7 x 12.7	6.5 x 18	8 x 18	10 x 18	10 x 25	-	12.5 x 30	15 x 30
330	-	-	-	-	10 x 30	-	12.5 x 30	18 x 30
470	6.5 x 18	8 x 18	10 x 18	10 x 25	12.5 x 30	-	15 x 30	18 x 38
680	-	-	-	10 x 30	12.5 x 30	-	18 x 30	21 x 38
1000	10 x 18	10 x 25	10 x 30	12.5 x 30	15 x 30	-	18 x 38	-
1500	-	10 x 30	12.5 x 30	15 x 30	18 x 30	-	21 x 38	-
2200	10 x 25	12.5 x 30	15 x 30	18 x 30	18 x 38	-	-	-
3300	-	15 x 30	18 x 30	18 x 38	21 x 38	-	-	-
4700	-	18 x 30	18 x 30	18 x 38	-	-	-	-
6800	-	18 x 38	18 x 38	21 x 38	-	-	-	-
10 000	-	18 x 38	21 x 38	-	-	-	-	-
15 000	-	21 x 38	-	-	-	-	-	-

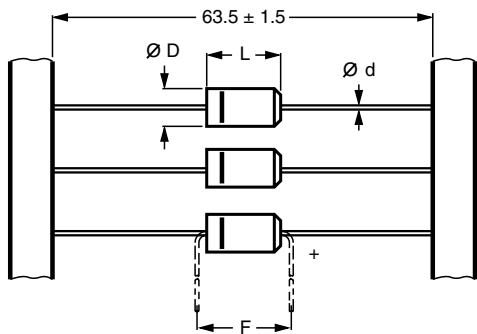
DIMENSIONS in millimeters AND AVAILABLE FORMS

Form BR: Taped on reel
 Form BA: Taped in box (ammopack)
 Case Ø D x L = 6.3 x 12.7 and 7.7 x 12.7 mm

Fig.2 Forms BA and BR

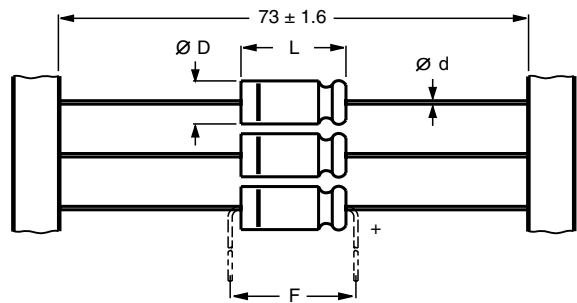

Form BR: Taped on reel,
 case Ø D x L = 6.5 x 18 to 15 x 30 mm
 Form BA: Taped in box (ammopack),
 case Ø D x L = 6.5 x 18 to 10 x 25 mm

Fig.3 Forms BA and BR

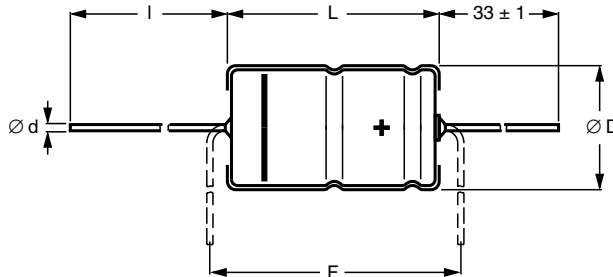

Form AA: Axial in box
 Case Ø D x L = 10 x 30 to 21 x 38 mm

Fig.4 Form AA

Table 1

AXIAL; DIMENSIONS in millimeters, MASS AND PACKAGING QUANTITIES										
NOMINAL CASE SIZE ∅ D x L (mm)	CASE CODE	AXIAL: FORM AA, BA, and BR					MASS (g)	PACKAGING QUANTITIES		
		∅ d	l	∅ D _{max}	L _{max}	F _{min}		FORM AA	FORM BA	FORM BR
6.3 x 12.7	(2)	0.6	-	6.5	12.9	17.5	≈ 1.1	-	1000	1000
7.7 x 12.7	(3)	0.6	-	7.9	12.9	17.5	≈ 1.3	-	500	500
6.5 x 18	4	0.8	-	6.9	18.5	25	≈ 1.3	-	1000	1000
8 x 18	5	0.8	-	8.5	18.5	25	≈ 1.7	-	500	500
10 x 18	6	0.8	-	10.5	18.5	25	≈ 2.5	-	500	500
10 x 25	7	0.8	-	10.5	25.0	30	≈ 3.3	-	500	500
10 x 30	00	0.8	55 ± 1	10.5	30.5	35	≈ 4.8	340	-	500
12.5 x 30	01	0.8	55 ± 1	13.0	30.5	35	≈ 7.4	260	-	400
15 x 30	02	0.8	55 ± 1	15.5	30.5	35	≈ 11.7	200	-	250
18 x 30	03	0.8	55 ± 1	18.5	30.5	35	≈ 12.9	120	-	-
18 x 38	04	0.8	34 ± 1	18.5	39.0	44	≈ 19.0	125	-	-
21 x 38	05	0.8	34 ± 1	21.5	39.0	44	≈ 24.0	100	-	-

Note

1. Detailed tape dimensions see section 'PACKAGING'.

Fig.5 Mounting hole diagram and outline; **Form MR**; mounting ring and pins

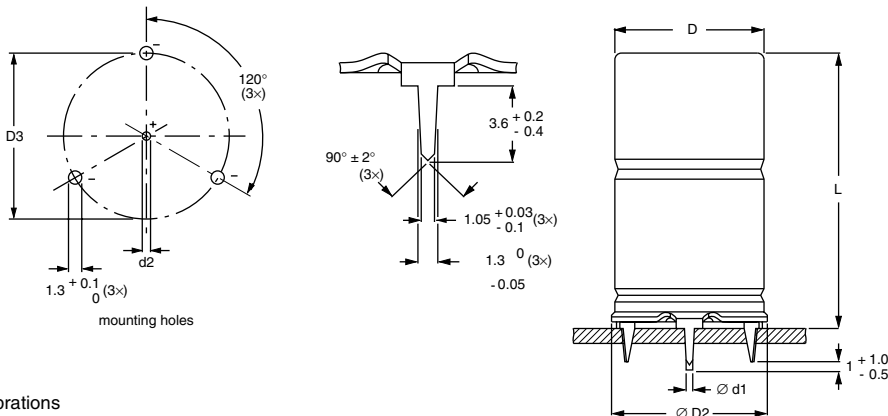

Form MR: case $\varnothing D \times L = 15 \times 30$ to 21×38 mm

Case not insulated (insulation on request)

Especially for applications with severe shocks and vibrations

Table 2

MOUNTING RING; DIMENSIONS in millimeters, MASS AND PACKAGING QUANTITIES									
NOMINAL CASE SIZE ∅ D x L	CASE CODE	MOUNTING RING: FORM MR						MASS (g)	PACKAGING QUANTITIES
		∅ d ₁	∅ d ₂	∅ D _{max}	∅ D _{2max}	D ₃	L _{max}		
15 x 30	02	0.8	1.0 + 0.4	15.5	17.5	16.5 ± 0.2	33	≈ 11.7	200
18 x 30	03	0.8	1.0 + 0.4	18.5	19.5	18.5 ± 0.2	33	≈ 12.9	240
18 x 38	04	0.8	1.0 + 0.4	18.5	19.5	18.5 ± 0.2	42	≈ 19.0	100
21 x 38	05	0.8	1.0 + 0.4	21.5	22.5	21.5 ± 0.2	42	≈ 24.0	100



Aluminum Capacitors
Axial Miniature, Long-Life

Vishay BCcomponents

ELECTRICAL DATA	
SYMBOL	DESCRIPTION
C _R	rated capacitance at 100 Hz, tolerance ± 20 %
I _R	rated RMS ripple current at 100 Hz, 105 °C
I _{L5}	max. leakage current after 5 minutes at U _R
tan δ	max. dissipation factor at 100 Hz
ESR	equivalent series resistance at 100 Hz (calculated from tan δ _{max} and C _R)
Z	max. impedance at 10 kHz or 100 kHz

ORDERING EXAMPLE*

Electrolytic capacitor 138 series

470 µF/10 V; ± 20 %

Nominal case size: Ø 8 × 18 mm; Form BA

Catalog number: 2222 138 34471

* Note: To ensure delivery of lead (Pb)-free parts during the transition period, please contact your Vishay sales agent.

Note

1. Unless otherwise specified, all electrical values in Table 3 apply at T_{amb} = 20 °C, P = 86 to 106 kPa, RH = 45 to 75 %.

Table 3

ELECTRICAL DATA AND ORDERING INFORMATION													
U _R (V)	C _R 100 HZ (µF)	NOMINAL CASE SIZE Ø D x L (mm)	I _R 100 Hz 105 °C (mA)	I _{L5} 5 min (µA)	Tan δ 100 Hz	ESR 100 Hz (Ω)	Z 10 kHz (Ω)	Z 100 kHz (Ω)	CATALOG NUMBER 2222 138				
									IN BOX FORM AA	TAPED ON REEL FORM BR	TAPED IN BOX FORM BA	MOUNTING RING FORM MR	
6.3	100	6.3 x 12.7	99	5.3	0.24	3.8	3.0	1.8	-	23101	33101	-	-
	220	7.7 x 12.7	160	6.8	0.24	1.7	1.4	0.95	-	23221	33221	-	-
	470	6.5 x 18	250	9.9	0.24	0.81	0.64	0.5	-	23471	33471	-	-
	1000	10 x 18	430	17	0.24	0.38	0.30	0.24	-	23102	33102	-	-
	2200	10 x 25	640	32	0.29	0.21	0.18	0.15	-	23222	33222	-	-
10	150	7.7 x 12.7	140	7.0	0.2	2.1	1.3	0.95	-	24151	34151	-	-
	220	6.5 x 18	190	8.4	0.2	1.4	0.91	0.5	-	24221	34221	-	-
	470	8 x 18	300	13	0.2	0.68	0.43	0.35	-	24471	34471	-	-
	1000	10 x 25	520	24	0.2	0.32	0.20	0.16	-	24102	34102	-	-
	1500	10 x 30	670	34	0.28	0.32	0.26	0.26	14152	24152	-	-	
	2200	12.5 x 30	890	48	0.29	0.22	0.19	0.19	14222	24222	-	-	
	3300	15 x 30	1140	70	0.30	0.16	0.13	0.15	14332	24332	-	44332	
	4700	18 x 30	1450	98	0.33	0.12	0.11	0.13	14472	-	-	44472	
	6800	18 x 38	1880	140	0.34	0.085	0.074	0.11	14682	-	-	44682	
	10 000	18 x 38	1980	200	0.41	0.070	0.062	0.10	14103	-	-	44103	
15 000	21 x 38	2200	300	0.55	0.063	0.058	0.099	14153	-	-	44153		
16	22	6.3 x 12.7	58	4.7	0.12	8.7	7.3	2.7	-	25229	35229	-	-
	47	6.3 x 12.7	83	5.5	0.16	5.4	3.4	1.9	-	25479	35479	-	-
	100	7.7 x 12.7	130	7.2	0.16	2.5	1.6	1.0	-	25101	35101	-	-
	220	8 x 18	230	11	0.16	1.2	0.73	0.35	-	25221	35221	-	-
	470	10 x 18	360	19	0.16	0.54	0.34	0.25	-	25471	35471	-	-
	1000	10 x 30	630	36	0.20	0.34	0.27	0.26	15102	25102	-	-	
	1500	12.5 x 30	860	52	0.20	0.23	0.19	0.19	15152	25152	-	-	
	2200	15 x 30	1090	74	0.21	0.17	0.14	0.15	15222	25222	-	45222	
	3300	18 x 30	1420	110	0.24	0.12	0.10	0.13	15332	-	-	45332	
	4700	18 x 30	1480	150	0.28	0.10	0.090	0.12	15472	-	-	45472	
6800	18 x 38	1930	220	0.28	0.072	0.062	0.10	15682	-	-	45682		
10 000	21 x 38	2100	320	0.38	0.065	0.057	0.098	15103	-	-	45103		
25	10	6.3 x 12.7	46	4.5	0.09	14	12	2.8	-	26109	36109	-	-
	22	6.3 x 12.7	61	5.1	0.14	10	5.5	2.5	-	26229	36229	-	-
	33	6.3 x 12.7	74	5.7	0.14	6.8	3.6	1.9	-	26339	36339	-	-
	47	7.7 x 12.7	96	6.4	0.14	4.7	2.6	1.0	-	26479	36479	-	-



ELECTRICAL DATA AND ORDERING INFORMATION													
U _R (V)	C _R 100 Hz (μF)	NOMINAL CASE SIZE ∅ D x L (mm)	I _R 100 Hz 105 °C (mA)	I _{L5} 5 min (μA)	Tan δ 100 Hz	ESR 100 Hz (Ω)	Z 10 kHz (Ω)	Z 100 kHz (Ω)	CATALOG NUMBER 2222 138				
									IN BOX FORM AA	TAPED ON REEL FORM BR	TAPED IN BOX FORM BA	MOUNTING RING FORM MR	
25	100	6.5 x 18	160	9.0	0.13	2.1	1.2	0.55	-	26101	36101	-	
	220	10 x 18	270	15	0.13	0.94	0.55	0.27	-	26221	36221	-	
	470	10 x 25	440	28	0.13	0.44	0.26	0.17	-	26471	36471	-	
	680	10 x 30	580	38	0.14	0.36	0.26	0.25	16681	26681	-	-	
	1000	12.5 x 30	790	54	0.15	0.25	0.18	0.19	16102	26102	-	-	
	1500	15 x 30	1020	79	0.15	0.17	0.13	0.15	16152	26152	-	46152	
	2200	18 x 30	1320	110	0.17	0.13	0.10	0.13	16222	-	-	46222	
	3300	18 x 38	1720	170	0.17	0.090	0.071	0.11	16332	-	-	46332	
	4700	18 x 38	1840	240	0.21	0.076	0.063	0.10	16472	-	-	46472	
	6800	21 x 38	2100	340	0.27	0.068	0.058	0.099	16682	-	-	46682	
40	33	7.7 x 12.7	91	6.6	0.11	5.3	2.7	1.0	-	27339	37339	-	
	47	6.5 x 18	120	7.8	0.10	3.4	1.9	0.65	-	27479	37479	-	
	100	8 x 18	180	12	0.10	1.6	0.9	0.40	-	27101	37101	-	
	220	10 x 25	350	22	0.10	0.72	0.41	0.20	-	27221	37221	-	
	330	10 x 30	490	30	0.09	0.47	0.32	0.30	17331	27331	-	-	
	470	12.5 x 30	650	42	0.09	0.34	0.23	0.22	17471	27471	-	-	
	680	12.5 x 30	750	58	0.10	0.25	0.18	0.18	17681	27681	-	-	
	1000	15 x 30	970	84	0.10	0.17	0.12	0.14	17102	27102	-	47102	
	1500	18 x 30	1250	120	0.12	0.13	0.098	0.12	17152	-	-	47152	
	2200	18 x 38	1640	180	0.12	0.093	0.069	0.10	17222	-	-	47222	
3300	21 x 38	1810	270	0.15	0.079	0.061	0.10	17332	-	-	47332		
50	10	6.3 x 12.7	51	5.0	0.09	14	7	2.7	-	21109	31109	-	
	22	7.7 x 12.7	82	6.2	0.09	6.5	3.2	1.1	-	21229	31229	-	
	100	10 x 18	230	14	0.08	1.3	0.7	0.30	-	21101	31101	-	
63	4.7	6.3 x 12.7	35	4.6	0.09	30	17	5	-	28478	38478	-	
	10	7.7 x 12.7	59	5.3	0.08	13	8	1.8	-	28109	38109	-	
	22	6.5 x 18	100	6.8	0.07	5.1	3.6	0.85	-	28229	38229	-	
	47	8 x 18	150	9.9	0.07	2.4	1.7	0.50	-	28479	38479	-	
	100	10 x 25	280	17	0.07	1.1	0.8	0.27	-	28101	38101	-	
	150	10 x 30	410	23	0.11	0.73	0.44	0.40	18151	28151	-	-	
	220	12.5 x 30	560	32	0.11	0.50	0.31	0.29	18221	28221	-	-	
	330	12.5 x 30	660	46	0.12	0.37	0.23	0.22	18331	28331	-	-	
	470	15 x 30	860	63	0.12	0.26	0.16	0.16	18471	28471	-	48471	
	680	18 x 30	1130	90	0.12	0.19	0.12	0.14	18681	-	-	48681	
1000	18 x 38	1460	130	0.12	0.13	0.086	0.11	18102	-	-	48102		
1500	21 x 38	1680	190	0.13	0.10	0.072	0.11	18152	-	-	48152		
100	1.0	6.3 x 12.7	16	4.2	0.09	140	55	10	-	29108	39108	-	
	2.2	6.3 x 12.7	24	4.4	0.09	65	25	8	-	29228	39228	-	
	4.7	7.7 x 12.7	40	4.9	0.08	27	17	5	-	29478	39478	-	
	10	6.5 x 18	67	6.0	0.07	11	8	2.4	-	29109	39109	-	
	22	8 x 18	100	8.4	0.07	5.1	3.6	1.4	-	29229	39229	-	
	47	10 x 25	190	13	0.07	2.4	1.7	0.67	-	29479	39479	-	
	68	10 x 30	300	18	0.07	1.7	1.1	0.97	19689	29689	-	-	
	100	12.5 x 30	410	24	0.07	1.1	0.77	0.67	19101	29101	-	-	
	150	15 x 30	550	34	0.07	0.78	0.52	0.46	19151	29151	-	49151	
	220	15 x 30	650	48	0.07	0.54	0.37	0.33	19221	29221	-	49221	
	330	18 x 30	880	70	0.08	0.38	0.27	0.24	19331	-	-	49331	
	470	18 x 38	1130	98	0.08	0.27	0.19	0.17	19471	-	-	49471	
	680	21 x 38	1330	140	0.09	0.21	0.14	0.14	19681	-	-	49681	

ADDITIONAL ELECTRICAL DATA			
PARAMETER	CONDITIONS	VALUE	
		AXIAL	MOUNTING RING
Voltage			
Surge voltage		$U_s \leq 1.15 \times U_R$	
Reverse voltage		$U_{rev} \leq 1 V$	
Current			
Leakage current	after 1 minute at U_R :		
	case $\varnothing D \times L = 6.3 \times 12.7$ and 7.7×12.7 mm	$I_{L1} \leq 0.02 C_R \times U_R + 3 \mu A$	
	case $\varnothing D \times L = 6.5 \times 18$ to 21×38 mm	$I_{L1} \leq 0.006 C_R \times U_R + 4 \mu A$	
	after 5 minutes at U_R	$I_{L5} \leq 0.002 C_R \times U_R + 4 \mu A$	
Inductance			
Equivalent series inductance (ESL)	case $\varnothing D \times L$ mm:		
	6.3 x 12.7	typ. 20 nH	-
	7.7 x 12.7	typ. 30 nH	-
	6.5 x 18	typ. 15 nH	-
	8 x 18	typ. 35 nH	-
	10 x 18	typ. 69 nH	-
	10 x 25	typ. 38 nH	-
	10 x 30	typ. 38 nH	-
	12.5 x 30	typ. 46 nH	-
	15 x 30	typ. 48 nH	typ. 39 nH
	18 x 30	typ. 50 nH	typ. 39 nH
	18 x 38	typ. 54 nH	typ. 39 nH
	21 x 38	typ. 59 nH	typ. 39 nH

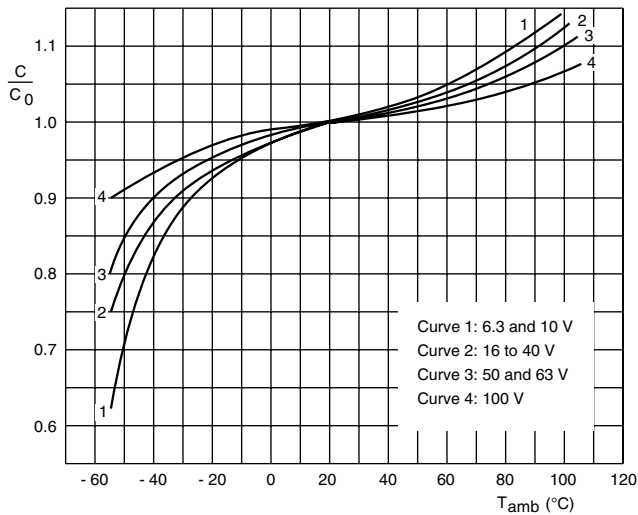
CAPACITANCE (C)

Case $\varnothing D \times L = 6.3 \times 12.7$ to 10×25 mm
 C_0 = capacitance at 20 °C, 100 Hz

Fig.6 Typical multiplier of capacitance as a function of ambient temperature

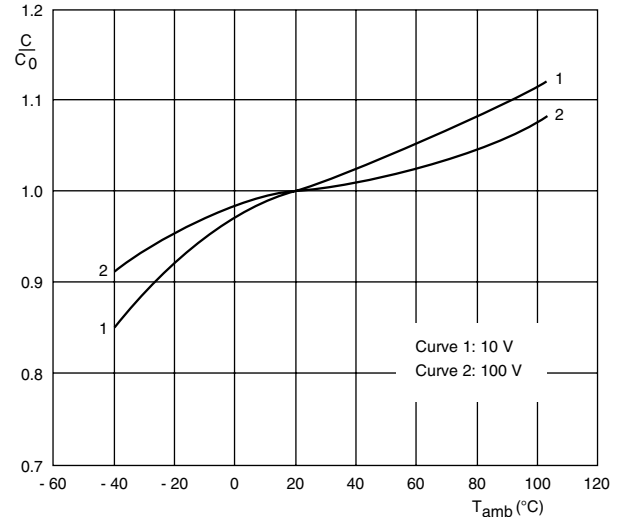

Case $\varnothing D \times L = 10 \times 30$ to 21×38 mm
 C_0 = capacitance at 20 °C, 100 Hz

Fig.7 Multiplier of capacitance as a function of ambient temperature

CAPACITANCE (C)

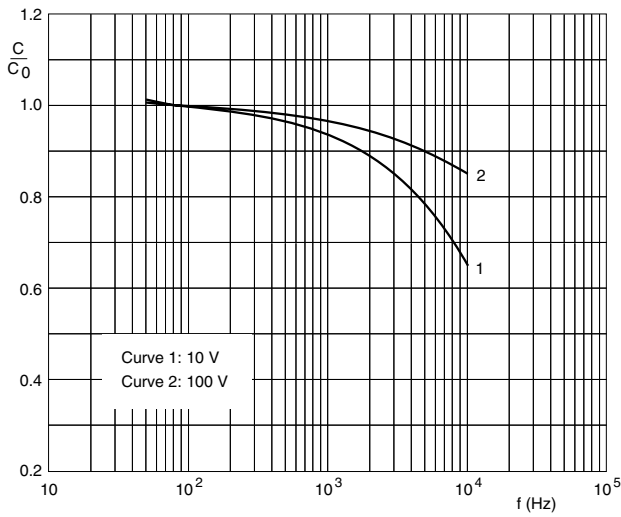

C_0 = capacitance at 20 °C, 100 Hz

Fig.8 Typical multiplier of capacitance as a function of frequency

EQUIVALENT SERIES RESISTANCE (ESR)

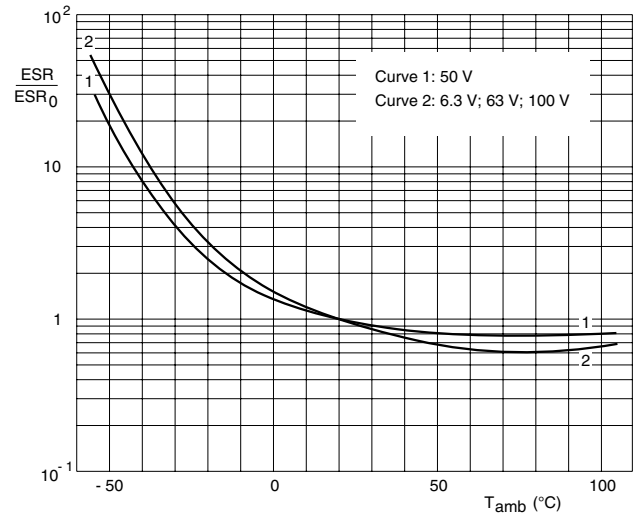

Case \varnothing D x L = 6.3 x 12.7 to 10 x 25 mm
ESR₀ = typical ESR at 20 °C, 100 Hz

Fig.9 Typical multiplier of ESR as a function of ambient temperature

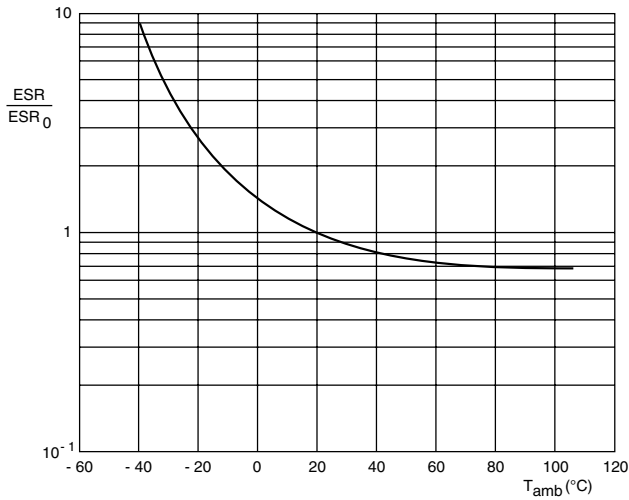

Case \varnothing D x L = 10 x 30 to 21 x 38 mm
ESR₀ = typical ESR at 20 °C, 100 Hz

Fig.10 Typical multiplier of ESR as a function of ambient temperature

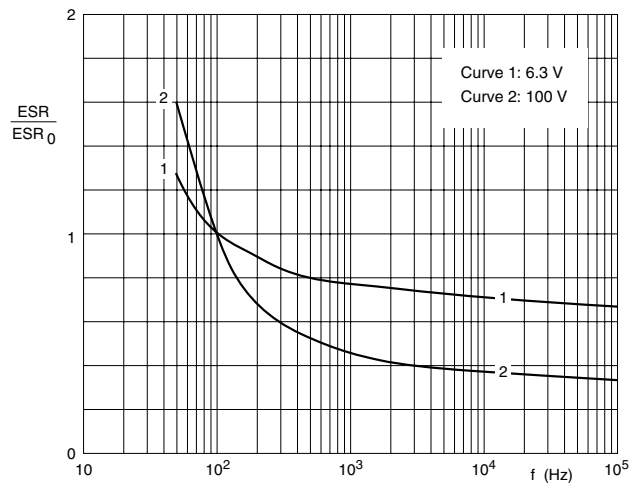

Case \varnothing D x L = 6.3 x 12.7 to 10 x 25 mm
ESR₀ = typical ESR at 20 °C, 100 Hz

Fig.11 Typical multiplier of ESR as a function of frequency

EQUIVALENT SERIES RESISTANCE (ESR)

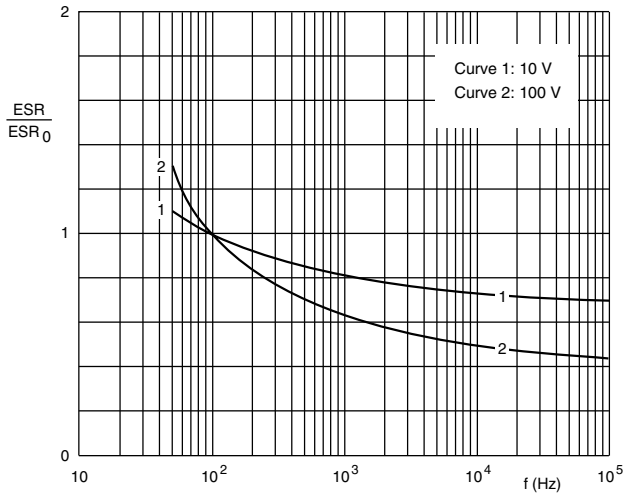

Case $\varnothing D \times L = 10 \times 30$ to 21×38 mm
ESR₀ = typical ESR at 20 °C, 100 Hz

Fig.12 Typical multiplier of ESR as a function of frequency

IMPEDANCE (Z)

Table 4

IMPEDANCE x CAPACITANCE VALUES (case $\varnothing D \times L = 6.3 \times 12.7$ to 10×25 mm)								
T _{amb}	Z x C _R (Ω x μF) AT 10 kHz							
	6.3 V	10 V	16 V	25 V	40 V	50 V	63 V	100 V
+ 20 °C	≤ 300	≤ 200	≤ 160	≤ 120	≤ 90	≤ 70	≤ 80	≤ 80
- 25 °C	≤ 2000	≤ 1200	≤ 750	≤ 560	≤ 450	≤ 300	≤ 550	≤ 550
- 40 °C	≤ 5500	≤ 3200	≤ 2000	≤ 1500	≤ 1200	≤ 900	≤ 1500	≤ 1500

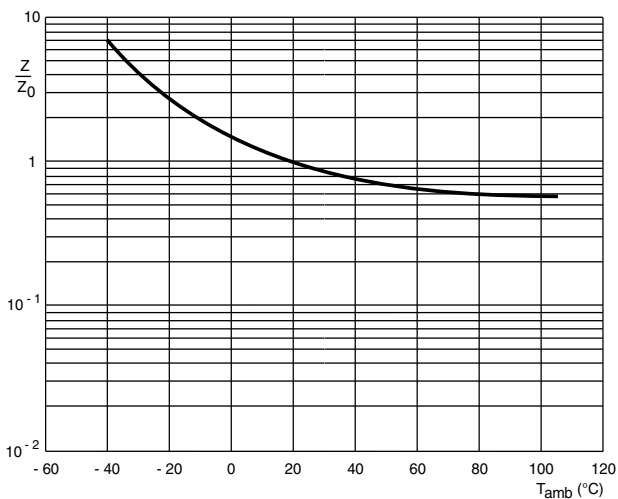

Case $\varnothing D \times L = 10 \times 30$ to 21×38 mm

Fig.13 Typical impedance as a function of ambient temperature at 10 kHz

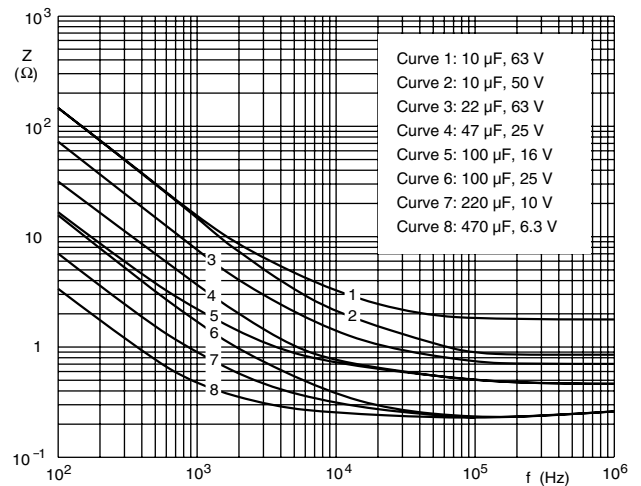

Case $\varnothing D \times L = 6.3 \times 12.7$ to 6.5×18 mm T_{amb} = 20 °C

Fig.14 Typical impedance as a function of frequency



IMPEDANCE (Z)

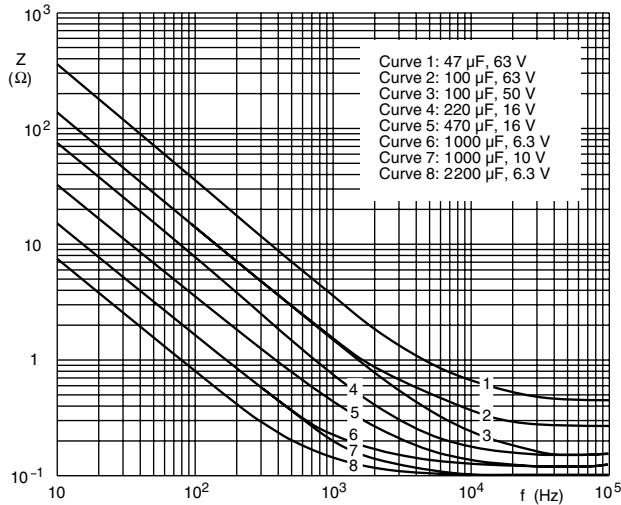

Case $\varnothing D \times L = 8 \times 18$ to 10×25 mm $T_{amb} = 20^\circ C$

Fig.15 Typical impedance as a function of frequency

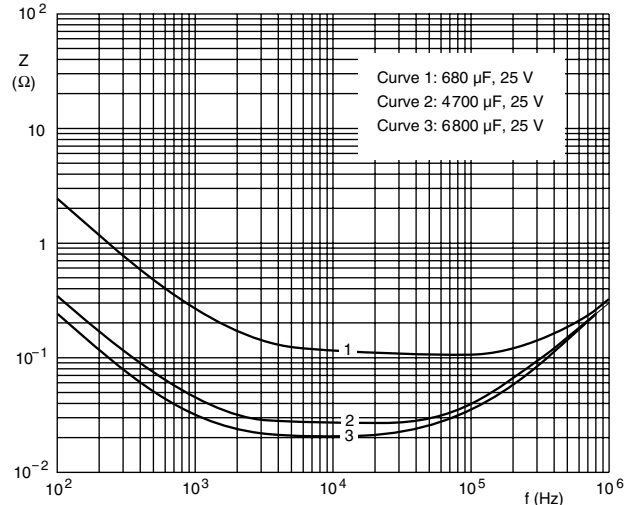

Case $\varnothing D \times L = 10 \times 30$ to 21×38 mm $T_{amb} = 20^\circ C$

Fig.16 Typical impedance as a function of frequency

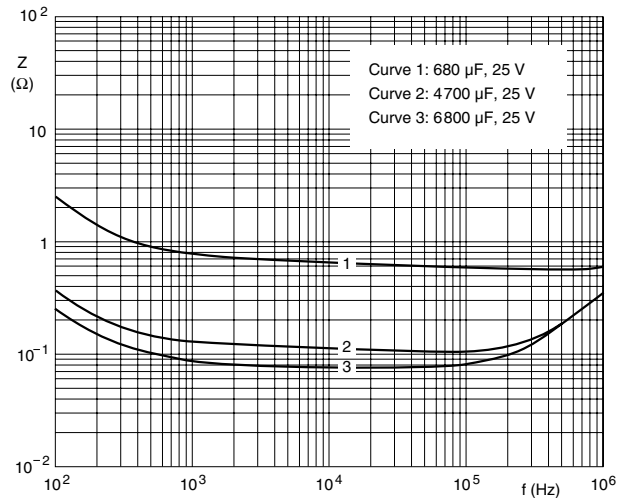

Case $\varnothing D \times L = 10 \times 30$ to 21×38 mm $T_{amb} = -25^\circ C$

Fig.17 Typical impedance as a function of frequency

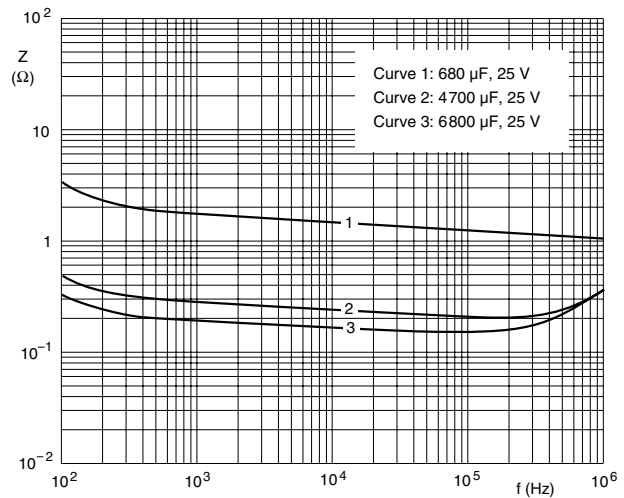

Case $\varnothing D \times L = 10 \times 30$ to 21×38 mm $T_{amb} = -40^\circ C$

Fig.18 Typical impedance as a function of frequency

RIPPLE CURRENT AND USEFUL LIFE

Fig.19 Multiplier of useful life as a function of ambient temperature and ripple current load

Table 5

MULTIPLIER OF RIPPLE CURRENT (I_R) AS A FUNCTION OF FREQUENCY			
FREQUENCY (Hz)	I_R MULTIPLIER		
	$U_R = 6.3$ to 10 V	$U_R = 16$ to 25 V	$U_R = 40$ to 100 V
50	0.95	0.90	0.85
100	1.00	1.00	1.00
300	1.07	1.12	1.20
1000	1.12	1.20	1.30
3000	1.15	1.25	1.35
$\geq 10\ 000$	1.20	1.30	1.40

Table 6

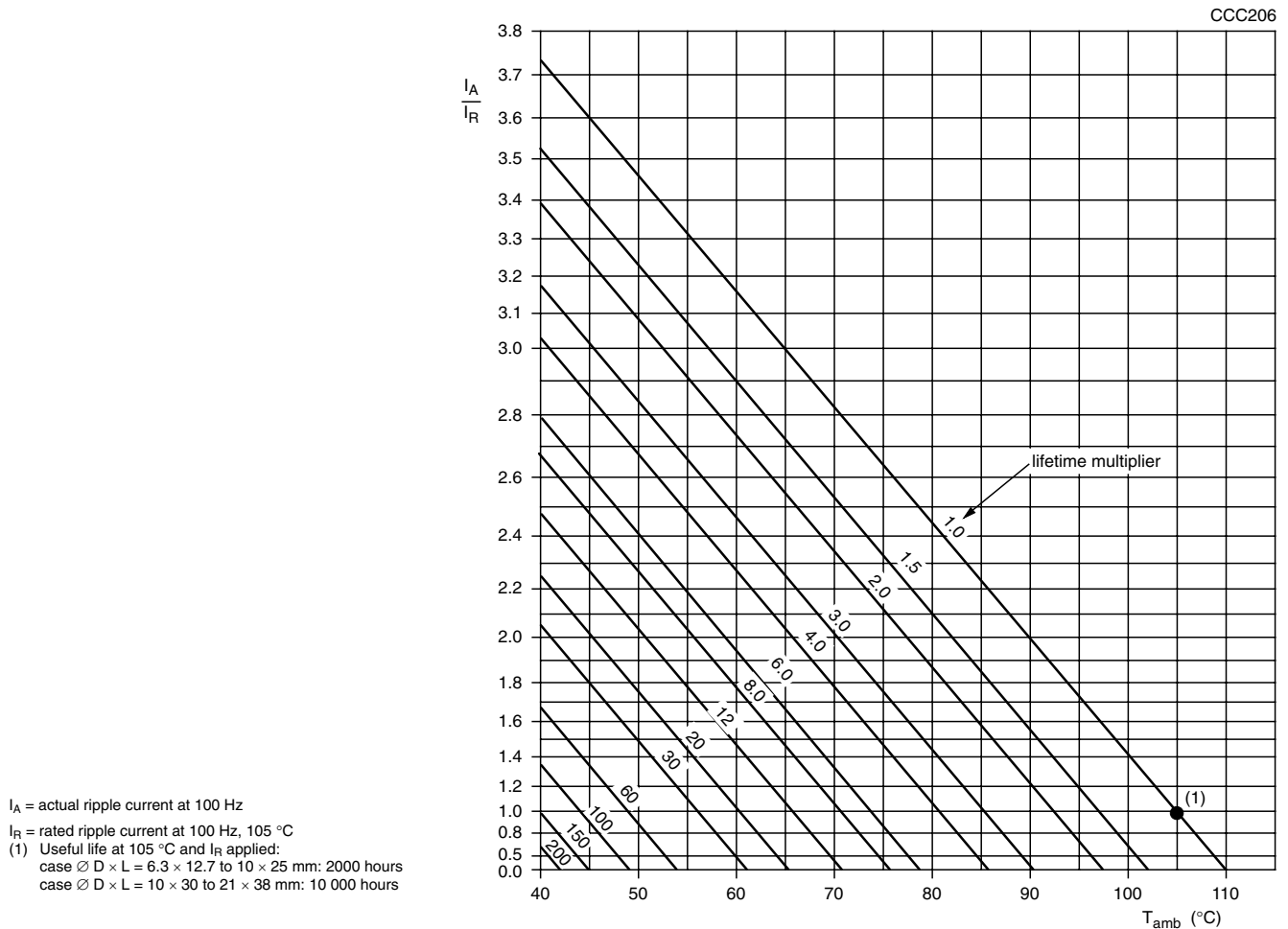
TEST PROCEDURES AND REQUIREMENTS			
TEST		PROCEDURE (quick reference)	REQUIREMENTS
NAME OF TEST	REFERENCE		
Endurance	IEC 60384-4/ EN130300 subclause 4.13	$T_{amb} = 105\text{ °C}$; U_R applied; case $\varnothing D \times L$: 6.3 x 12.7 to 10 x 25 mm: 1000 hours; 10 x 30 to 21 x 38 mm: 5000 hours	$U_R \leq 6.3\text{ V}$; $\Delta C/C$: + 15/- 30 % $U_R > 6.3\text{ V}$; $\Delta C/C$: $\pm 15\%$ $\tan \delta \leq 1.3 \times \text{spec. limit}$ $Z \leq 2 \times \text{spec. limit}$ $I_{L5} \leq \text{spec. limit}$
Useful life	CECC 30301 subclause 1.8.1	$T_{amb} = 105\text{ °C}$; U_R and I_R applied; case $\varnothing D \times L$: 6.3 x 12.7 to 10 x 25 mm: 2000 hours; 10 x 30 to 21 x 38 mm: 10 000 hours	$U_R \leq 6.3\text{ V}$; $\Delta C/C$: + 45/- 50 % $U_R > 6.3\text{ V}$; $\Delta C/C$: $\pm 45\%$ $\tan \delta \leq 3 \times \text{spec. limit}$ $Z \leq 3 \times \text{spec. limit}$ $I_{L5} \leq \text{spec. limit}$ no short or open circuit total failure percentage: $\leq 1\%$
Shelf life (storage at high temperature)	IEC 60384-4/ EN130300, subclause 4.17	$T_{amb} = 105\text{ °C}$; no voltage applied; 500 hours after test: U_R to be applied for 30 minutes, 24 to 48 hours before measurement	$\Delta C/C$, $\tan \delta$, Z : for requirements see 'Endurance test' above $I_{L5} \leq 2 \times \text{spec. limit}$



Notice

Specifications of the products displayed herein are subject to change without notice. Vishay Intertechnology, Inc., or anyone on its behalf, assumes no responsibility or liability for any errors or inaccuracies.

Information contained herein is intended to provide a product description only. No license, express or implied, by estoppel or otherwise, to any intellectual property rights is granted by this document. Except as provided in Vishay's terms and conditions of sale for such products, Vishay assumes no liability whatsoever, and disclaims any express or implied warranty, relating to sale and/or use of Vishay products including liability or warranties relating to fitness for a particular purpose, merchantability, or infringement of any patent, copyright, or other intellectual property right.

The products shown herein are not designed for use in medical, life-saving, or life-sustaining applications. Customers using or selling these products for use in such applications do so at their own risk and agree to fully indemnify Vishay for any damages resulting from such improper use or sale.