



Superior Magnetics Since 1979

CMOQ-2

LINE OUTPUT TRANSFORMER Quadfilar Windings

- \$ Excellent bandwidth -0.35 dB at 200 kHz
- \$ $R_s=150\Omega$ 80% Nickel ("HiNi") laminations
- \$ Distortion 0.01% typ at 20 Hz, $R_s=150\Omega$ HiNi
- \$ +23 dBm at 20 Hz, 1% THD+N $R_s\leq 150\Omega$
- \$ Phase Shift -5° at 20 kHz, $R_s=150\Omega$
- \$ Low insertion loss

The CineMag CMOQ-2 output transformer uses quadfilar construction techniques. This four-winding transformer delivers good coupling between windings as well as excellent bandwidth. It is available both with 80% Nickel ("HiNi") and 50% Nickel/50% Steel laminations. It can be driven with source impedances of up to 600Ω. As with all line driving devices, the amplifier feeding it should be capable of cleanly delivering the power required to reach maximum operating level. See AN-102.

CMOQ-2H / CMOQ-2L

Parameter	Conditions	Typ
Turns Ratio		1 : 1.00
Input Impedance, Zi	20 Hz to 20 kHz, 0 dBu Test Circuit 4	680Ω
Voltage Gain	1 kHz HiNi Core, $R_s=150$ Test Circuit 1 1 kHz 50% Nickel/50% Steel Core, $R_s=150$	-2.75 dB -2.78 dB
Distortion (THD+N%)	1 kHz, +4 dBu, $R_s=150$ HiNi Test Circuit 1 1 kHz, +4 dBu, $R_s=150$ 50%Ni/50% Steel	0.0004% 0.0006%
Max 20 Hz input level	1.0% THD+N, $R_s\leq 150$ HiNi Test Circuit 1 1.0% THD+N, $R_s\leq 150$ 50% Ni 50% Steel	+22 dB +22 dB
Response, ref 1 kHz	20 Hz $R_s=150\Omega$ HiNi Test Circuit 1 20 kHz $R_s=150\Omega$ HiNi Test Circuit 1 200 kHz $R_s=150\Omega$ HiNi Test Circuit 1	-0.02 dB -0.02 dB -1.45 dB
Phase Shift at 20Hz Phase Shift at 20 kHz	Referenced to source generator Test Circuit 1	+1° -5°
CMRR	60 Hz Test Circuit 2 per IEEE Std 389- 1996 ¶19 1 kHz Test Circuit 2 per IEEE Std 389-1996 ¶19	88 dB 92 dB
Output CMRR	60 Hz Test Circuit 3 1 kHz Test Circuit 3	92 dB 98 dB
Operating Temp Range	Operation and storage	0° C Min 70° C Max

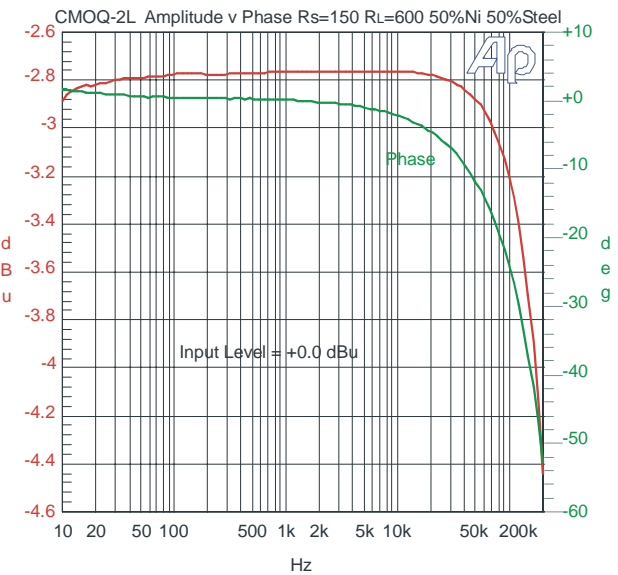
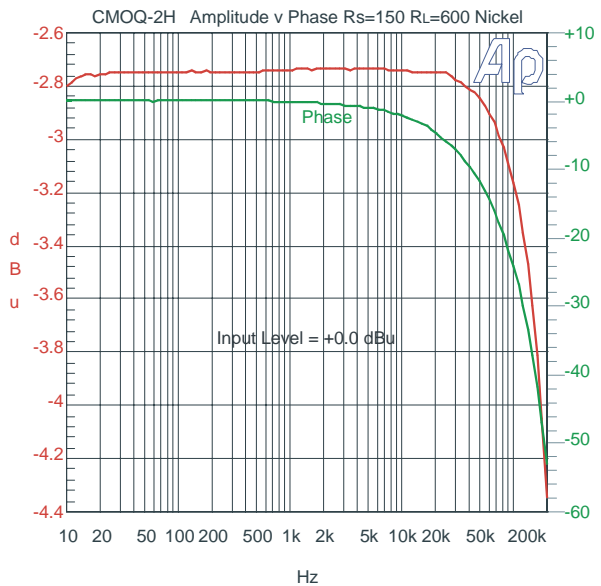
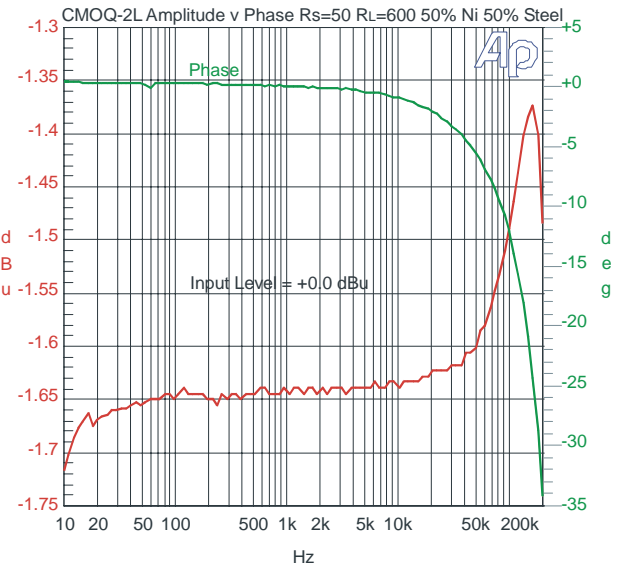
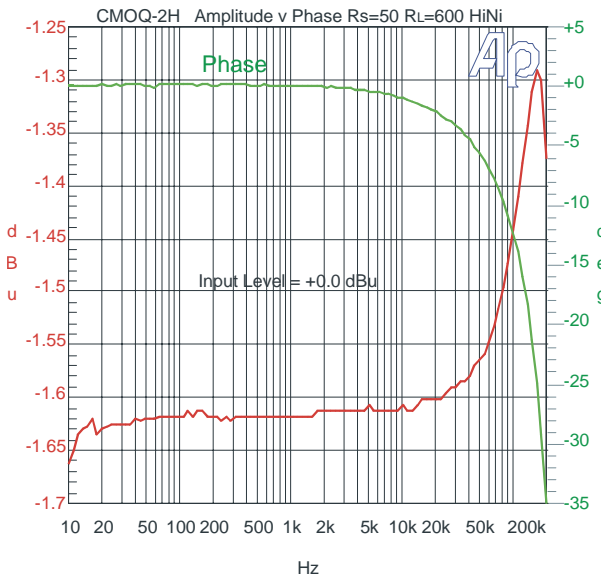
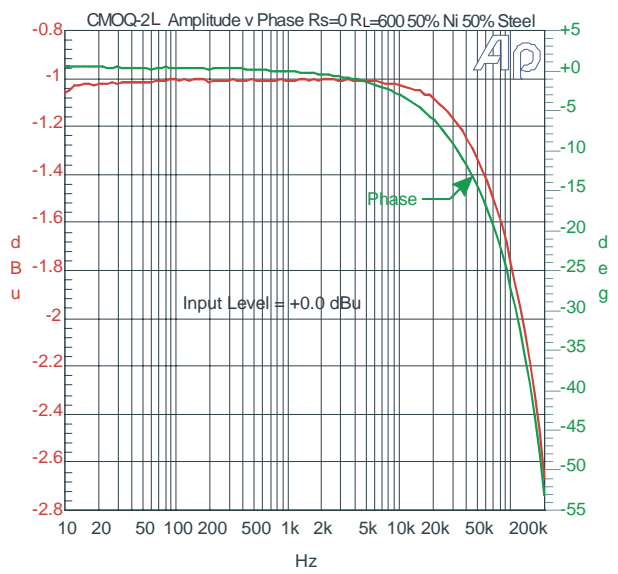
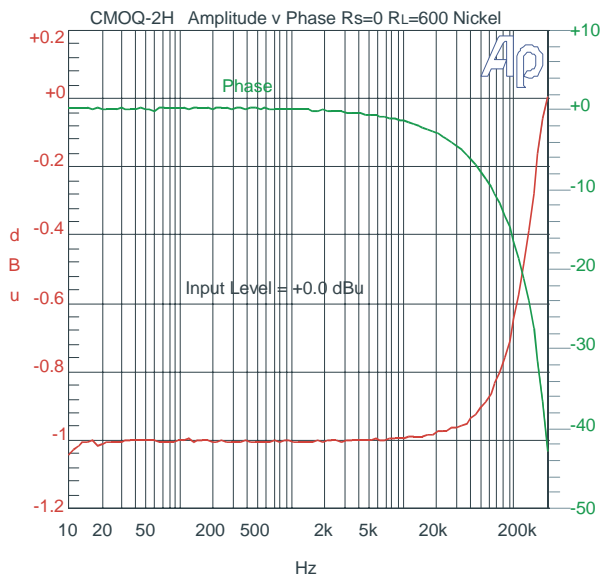

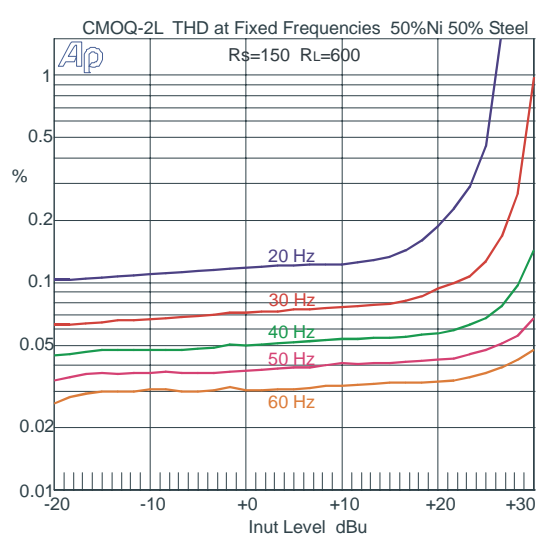
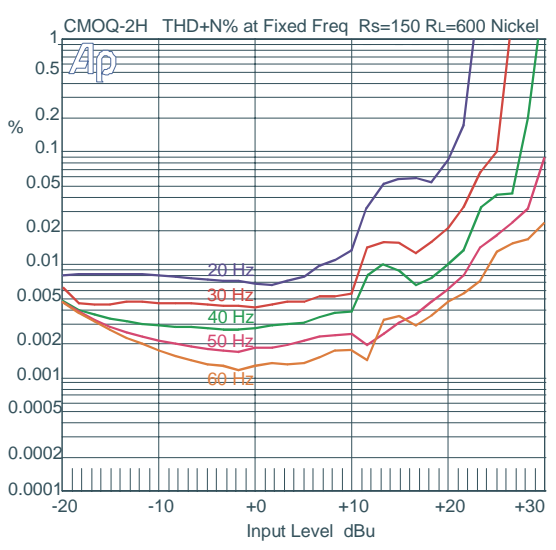
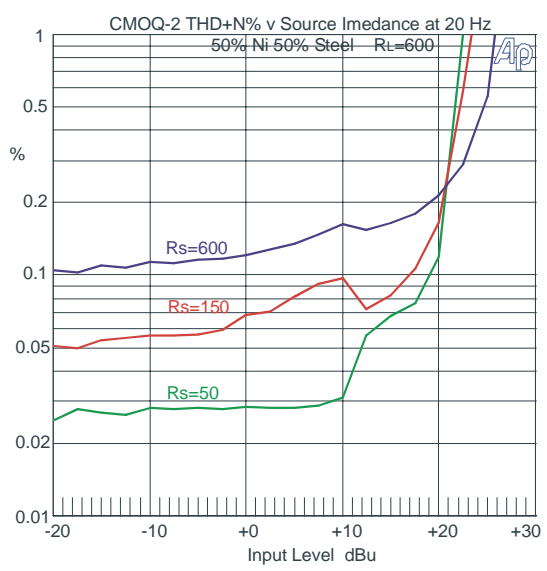
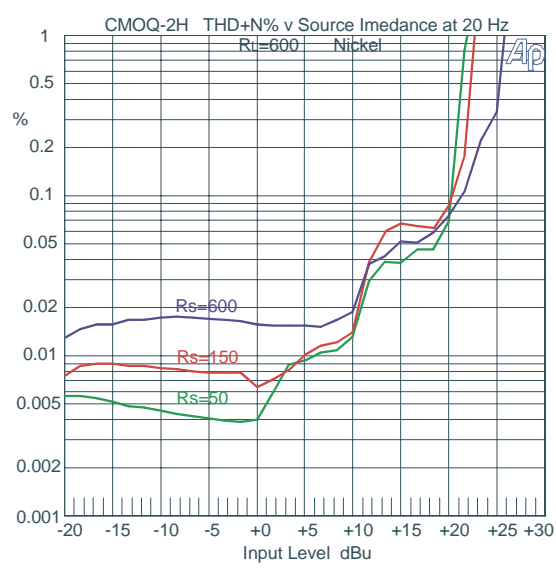
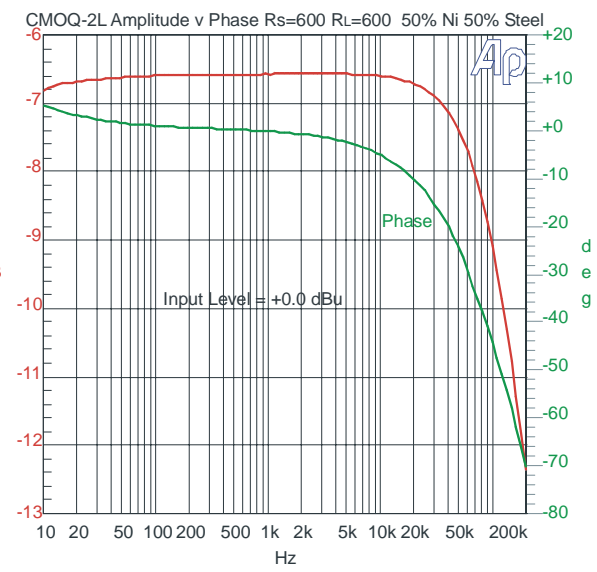
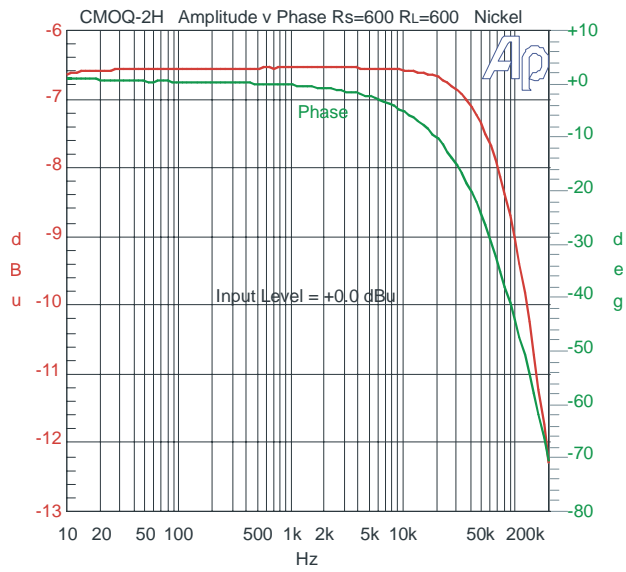

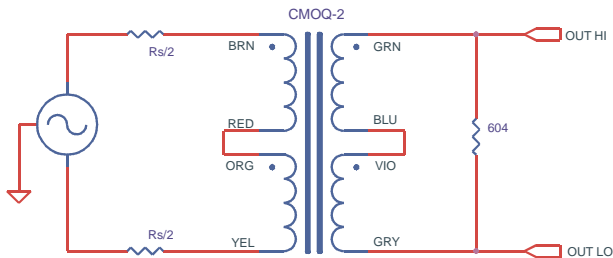
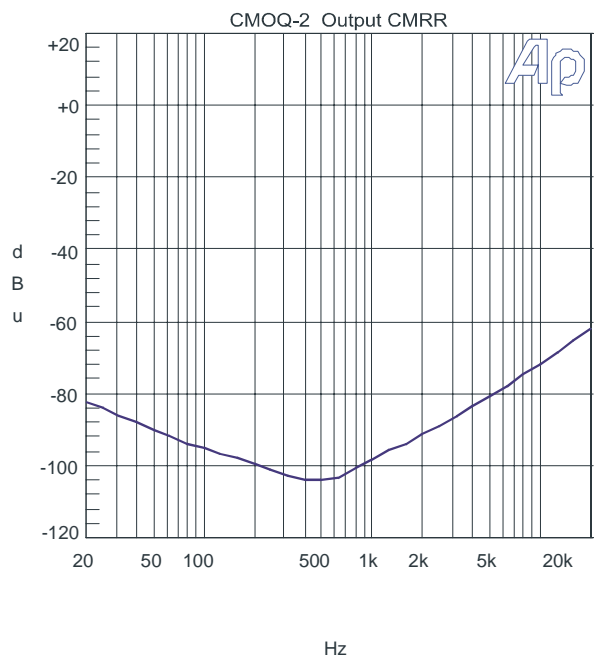
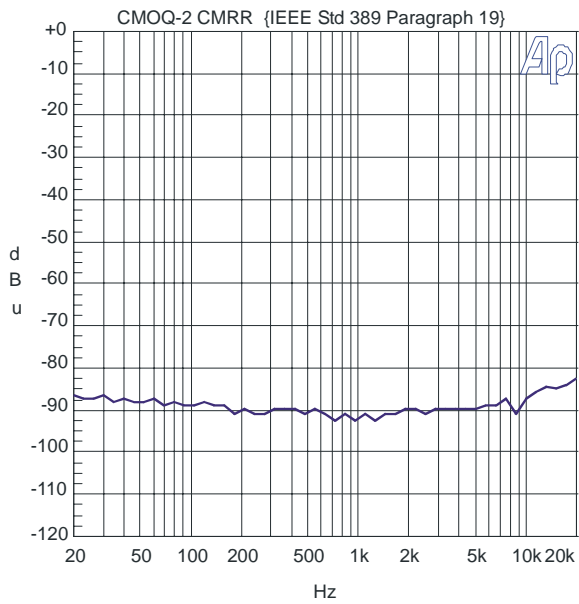
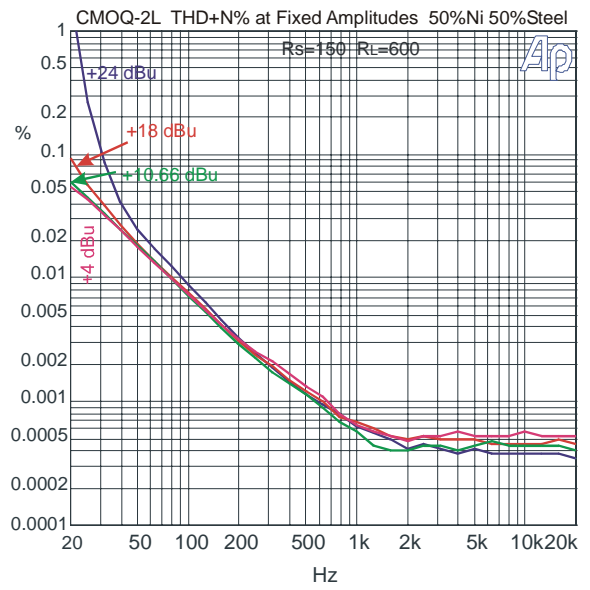
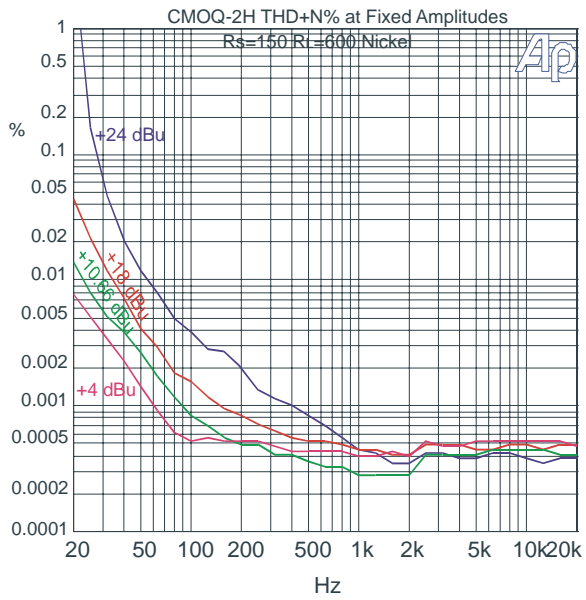

TEST CIRCUIT 1

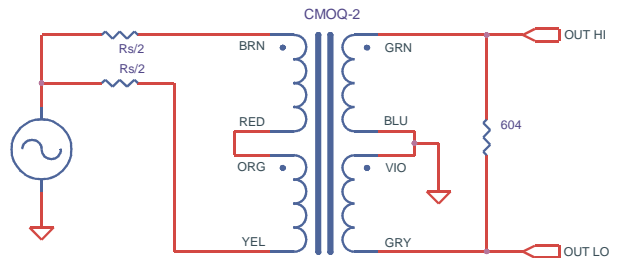

TEST CIRCUIT 2

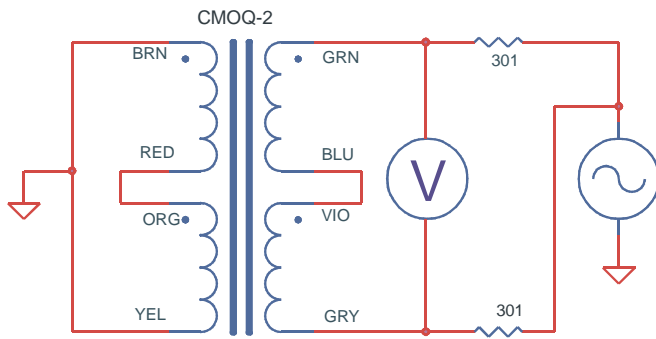

TEST CIRCUIT 3

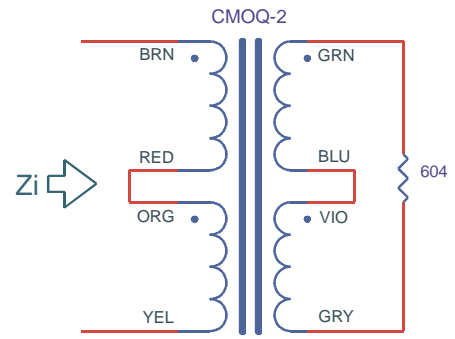

TEST CIRCUIT 4

NOTES:

1. All graphs generated from one (1) randomly chosen device. No statistical averaging or weighting. Data from one sweep.
2. $R_L = 604$ unless otherwise noted.

